

---

---

---

- 
- 
- 
- 
- 
-

---

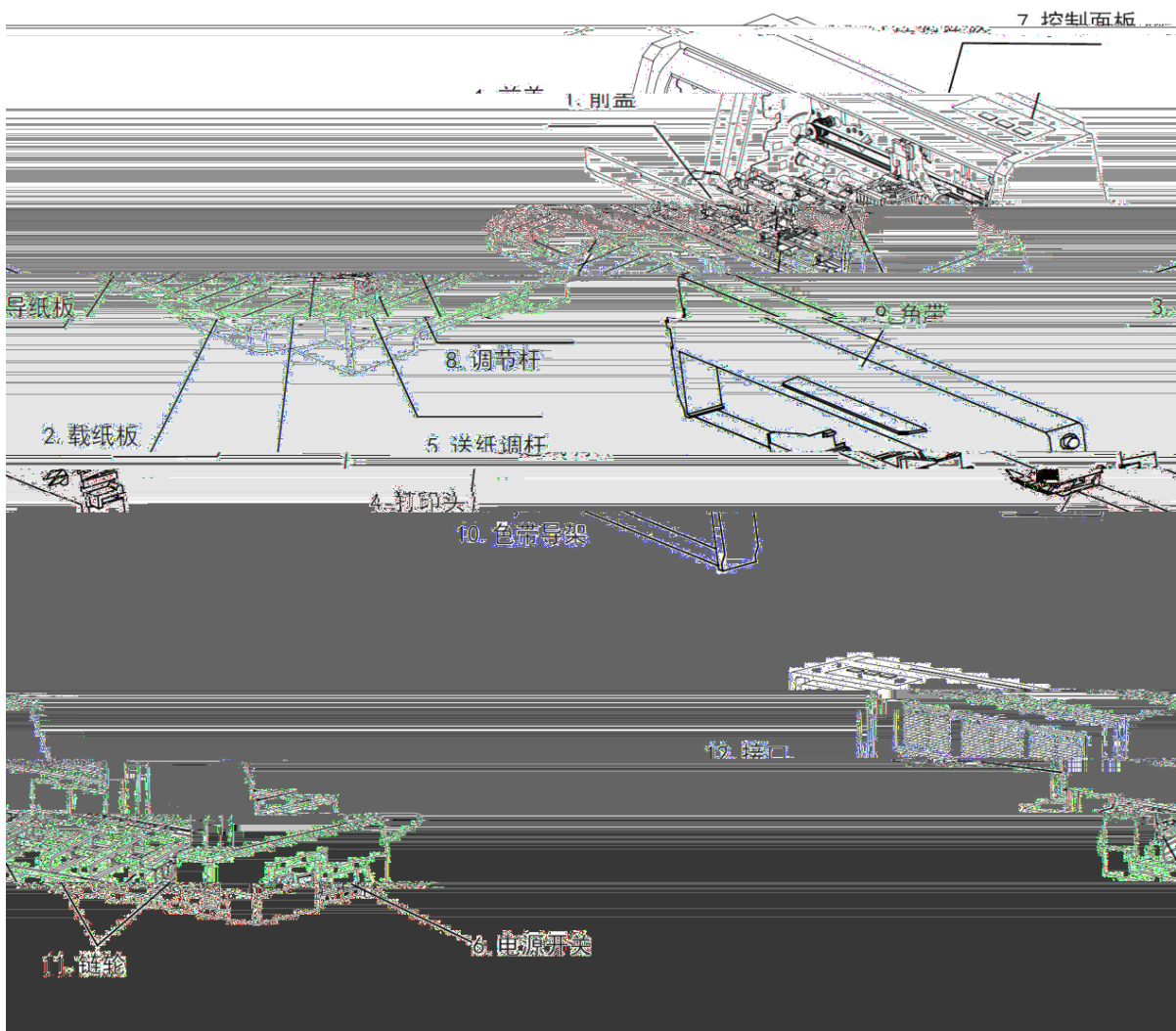
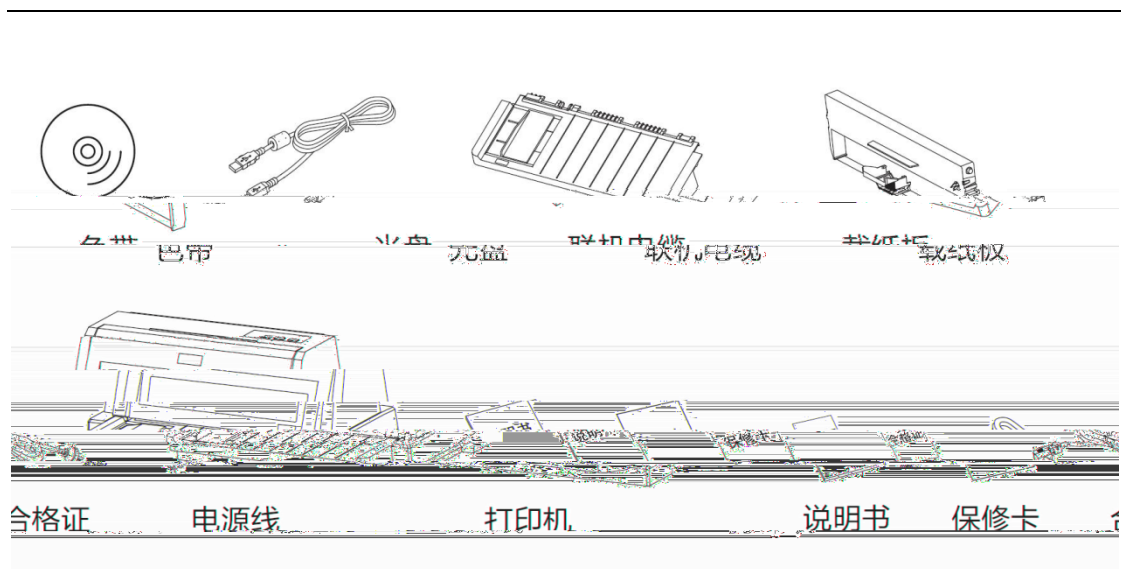

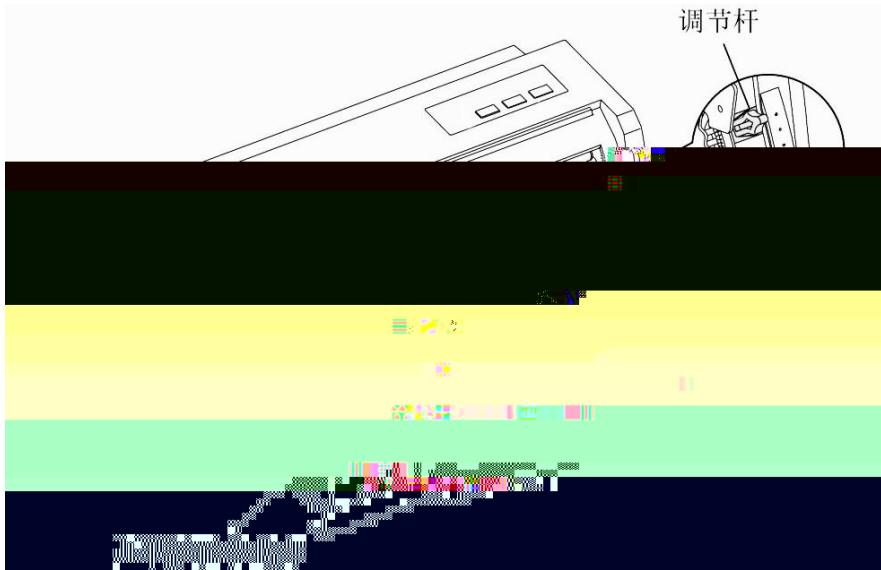

---



载纸板固定夹  
(左右对称)

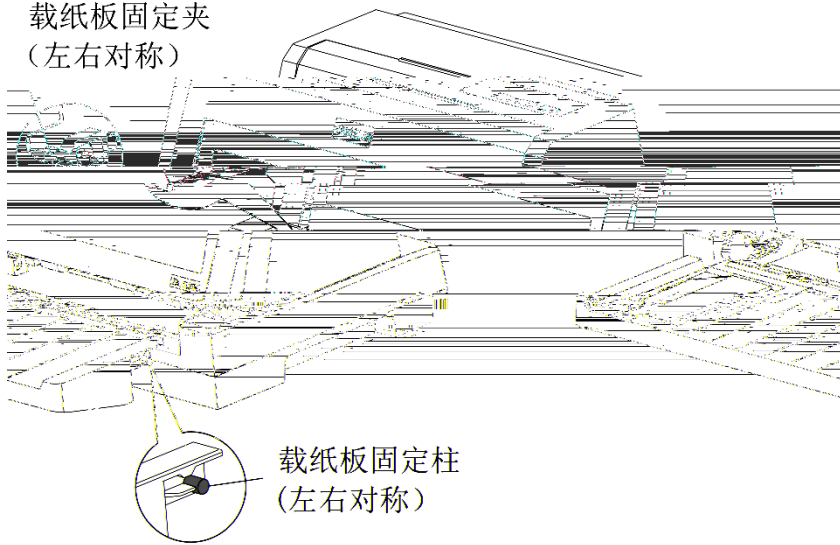



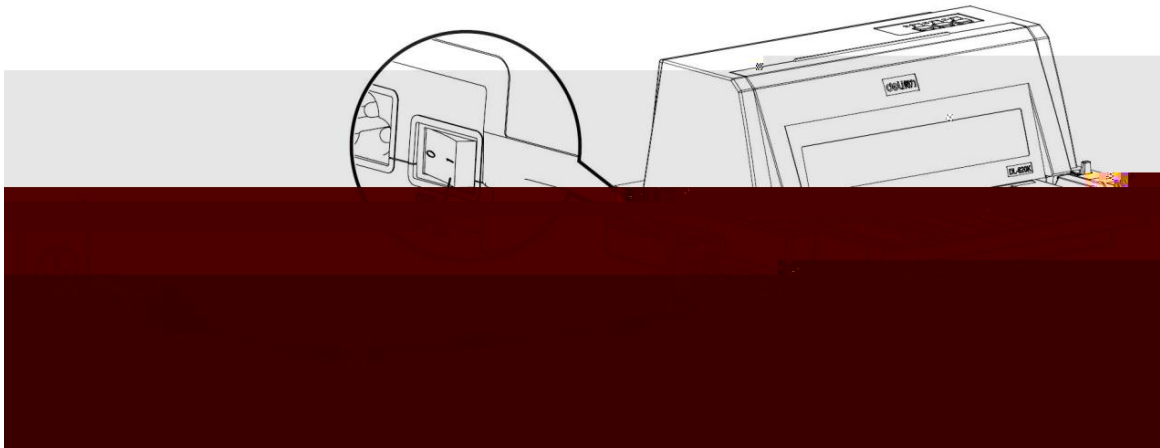
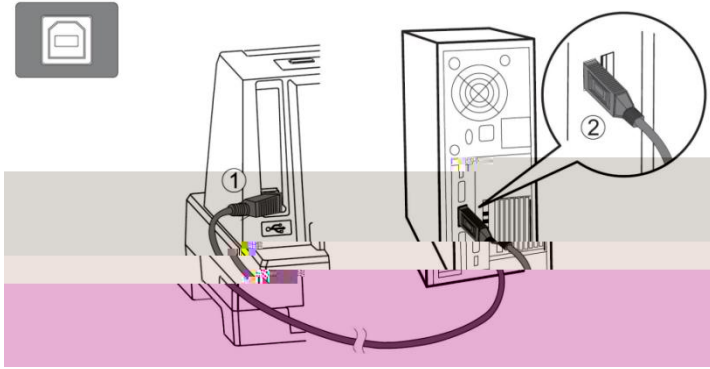

- |    |   |
|----|---|
| 1. | 5 |
| 2. |   |



---

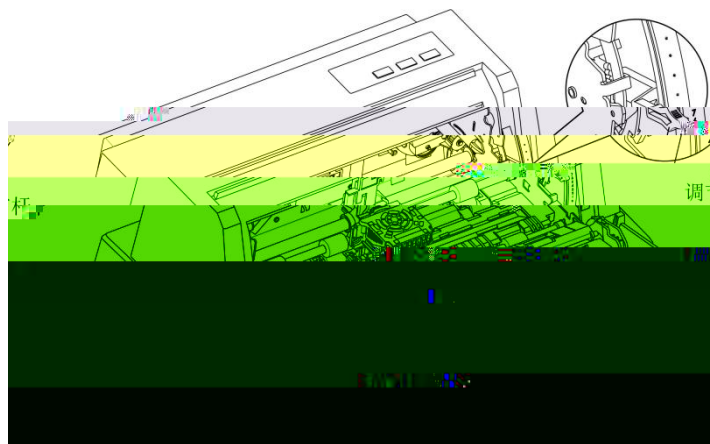
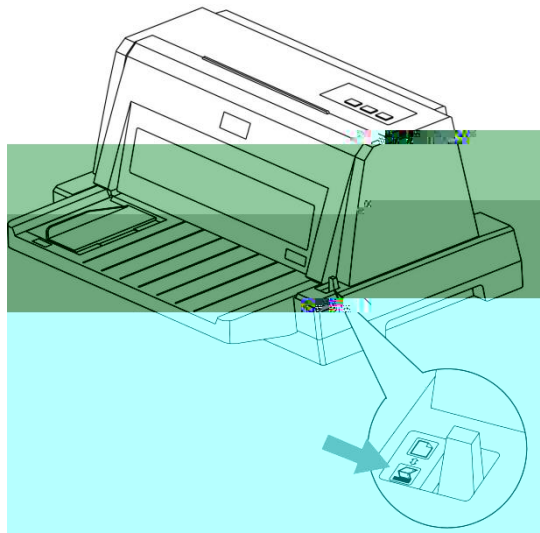
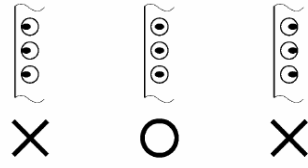

Å f j l, 7• K., 1/2 Ě Zûµ &V0 %‰žìiĀ 7• / @"X X1^0š Ö jđQSiPqT€ š N•ĀfØ ¯»T²âĚÖ

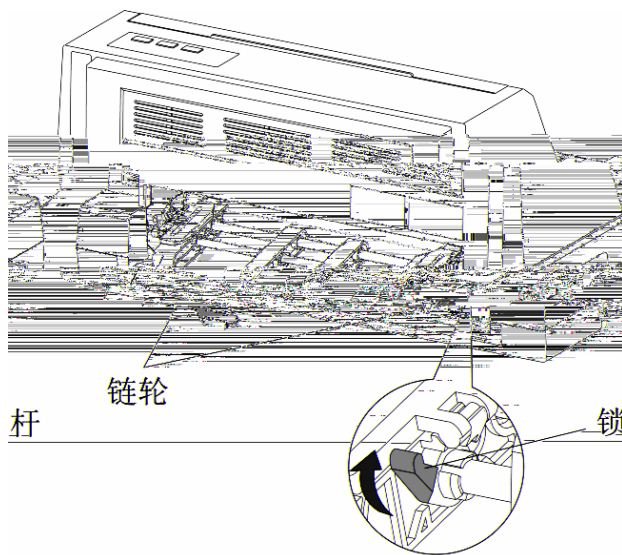
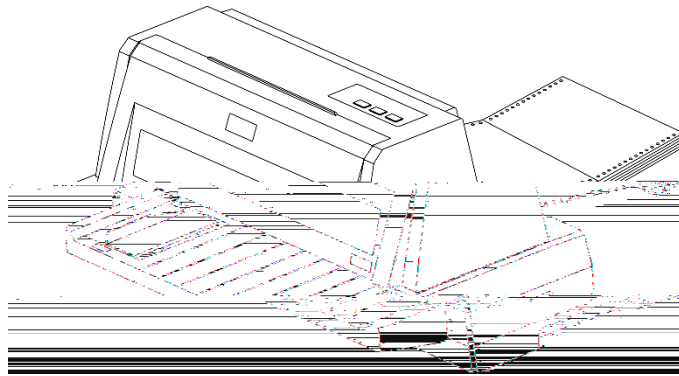

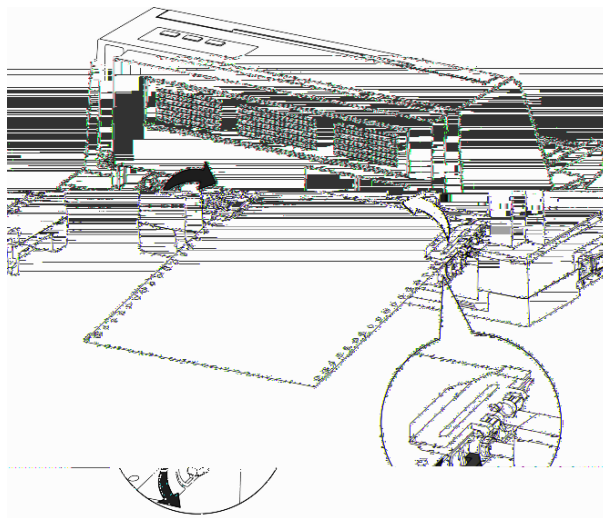
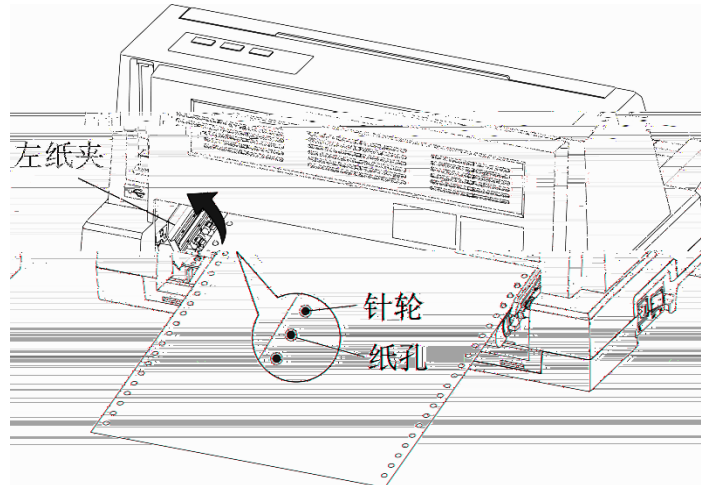

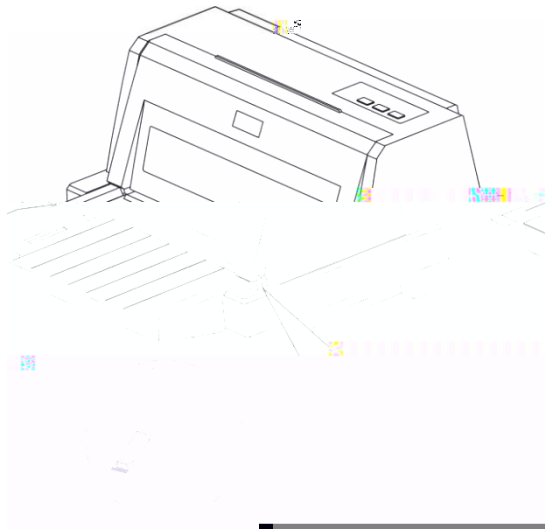

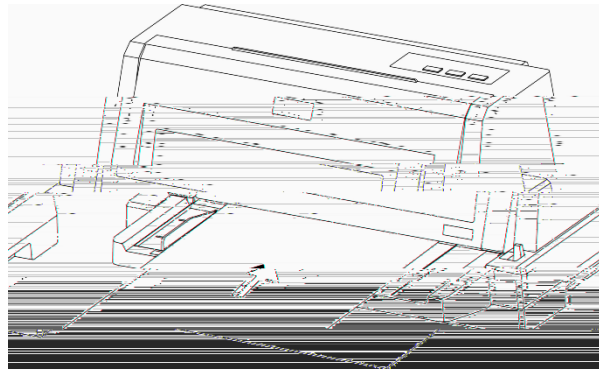
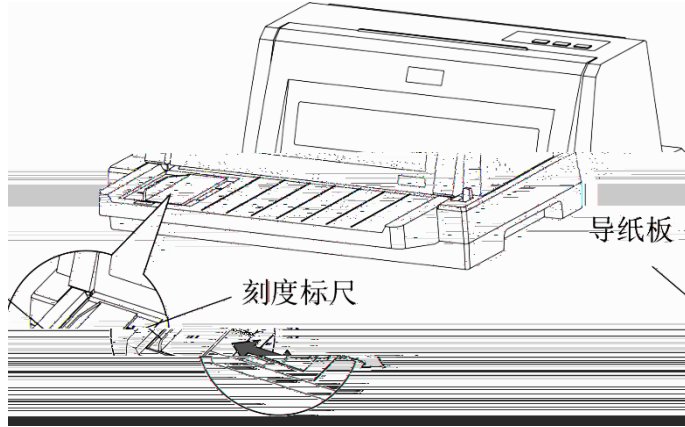





---

	2	+1
	3	+2
	4	+3
	5	+4
	6	+5
	7	+6

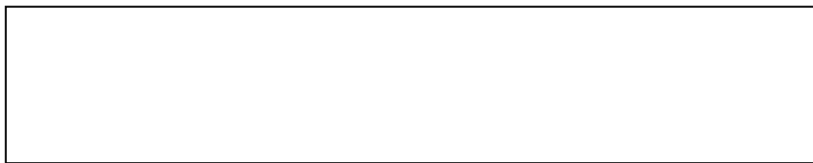

Windows 2000 / XP / Vista / 7 / 8 / 10

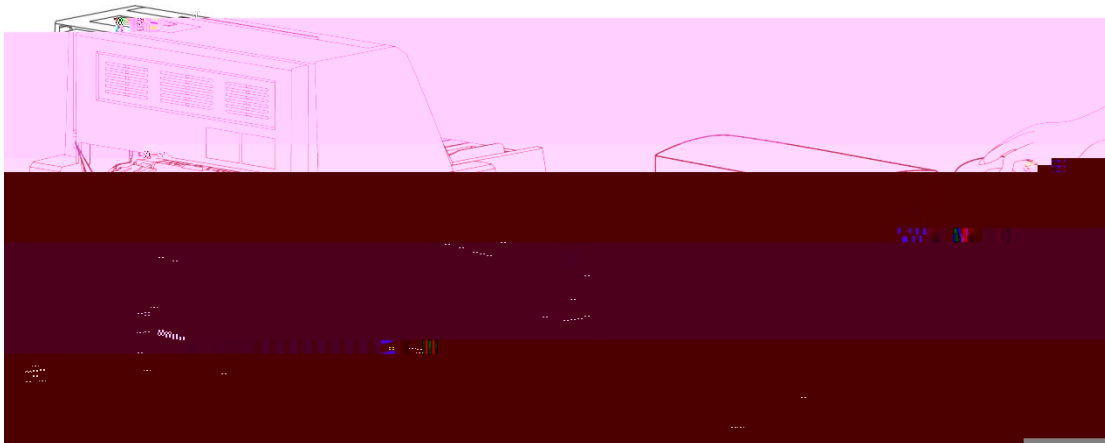

---

a.

DeliDriver.exe

---



---





---



---



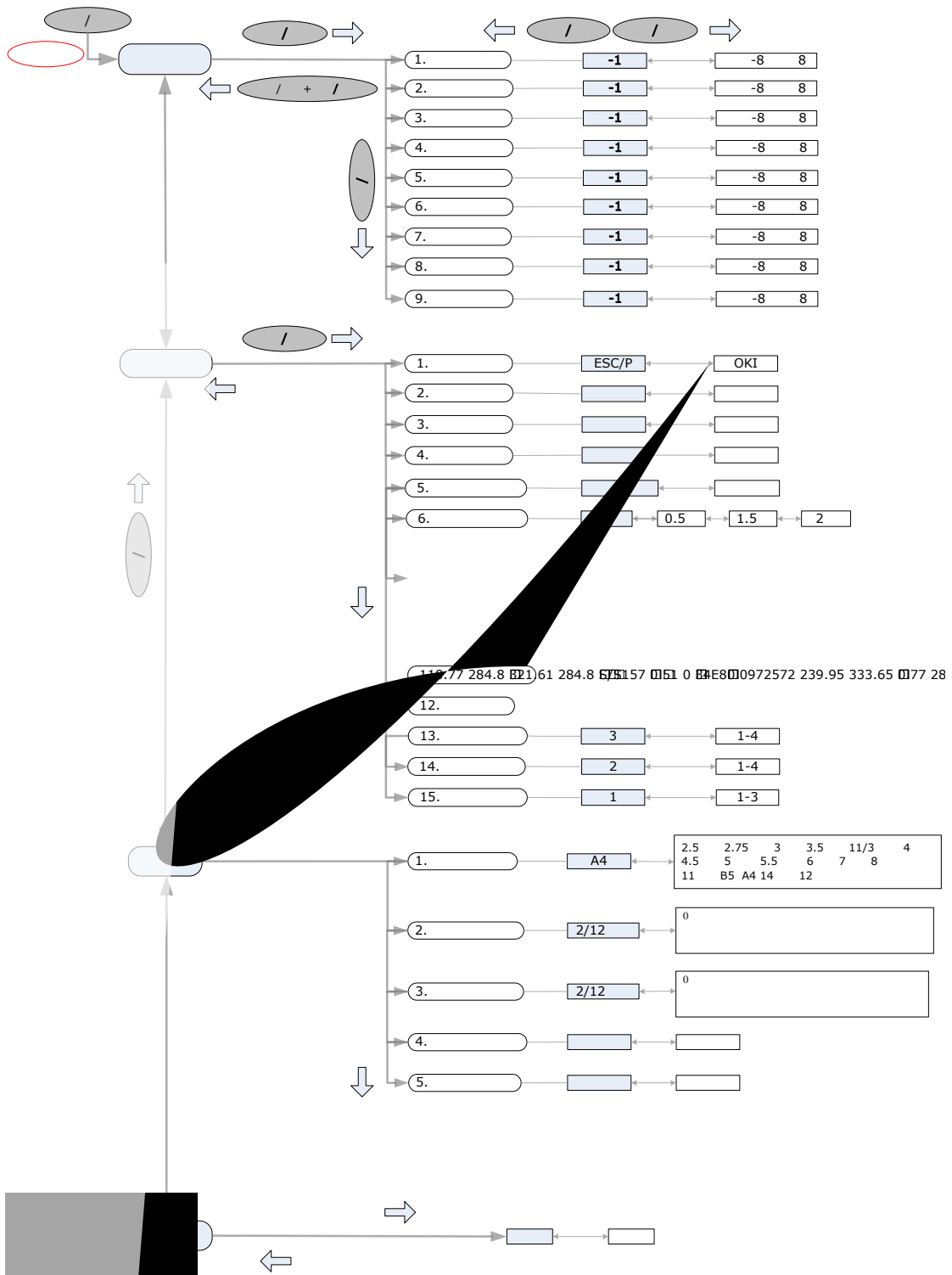



---

①

②

---

①

②

--

---



---

0

0

---

---







---





---



有毒有害物质或元素						
名称 (CPDE)	部件名称	铅 (Pb)	汞 (Hg)	镉 (Cd)	铬 (Cr)	多溴联苯 (PBB)
	导线					
	印刷电路板					
	塑料					
	油漆					
	五金					
	标签					
	其他金属					

注：1. 360-7000 系列产品的限量符合以下：  
 0 表示该有害物质在该部件所有均质材料中的含量均

中华人民共和国境内销售的电子信息产品必须标识此标志，标志内的数字代表在正常的使用状态下的产品的环保使用期限。

